

**ANNEX 7**

**RESOLUTION MSC.415(97)  
(adopted on 25 November 2016)**

**AMENDMENTS TO PART B OF THE INTERNATIONAL  
CODE ON INTACT STABILITY, 2008 (2008 IS CODE)**

THE MARITIME SAFETY COMMITTEE,

RECALLING Article 28(b) of the Convention on the International Maritime Organization concerning the functions of the Committee,

RECALLING ALSO resolution MSC.267(85) by which it adopted the International Code on Intact Stability, 2008 ("2008 IS Code"),

NOTING the provisions regarding the procedure for amendments to part B of the 2008 IS Code, stipulated in regulation II-1/2.27.2 of the International Convention for the Safety of Life at Sea, 1974 ("the SOLAS Convention"), as amended by resolution MSC.269(85), and in paragraph (16).2 of regulation I/3 of the Protocol of 1988 relating to the International Convention on Load Lines, 1966 ("1988 Load Lines Protocol"), as amended by resolution MSC.270(85),

RECOGNIZING the need to include provisions regarding ships engaged in anchor handling, lifting and towing operations, including escort towing, in the 2008 IS Code,

HAVING CONSIDERED, at its ninety-seventh session, the proposed amendments to part B of the 2008 IS Code, prepared by the Sub-Committee on Ship Design and Construction, at its second session,

1 ADOPTS amendments to part B of the 2008 IS Code, the text of which is set out in the annex to the present resolution;

2 RECOMMENDS Governments concerned to use the amendments to part B of the 2008 IS Code as a basis for relevant safety standards, unless their national stability requirements provide at least an equivalent degree of safety;

3 INVITES Contracting Governments to the SOLAS Convention and Parties to the 1988 Load Lines Protocol to note that the above amendments to the 2008 IS Code will take effect on 1 January 2020.

ANNEX

**AMENDMENTS TO PART B OF THE 2008 IS CODE**

- 1 The title of part B is replaced with the following text:

**"Part B**

*Recommendations for ships engaged in certain types of operations, certain types of ships and additional guidelines"*

**Chapter 1 – General**

**1.2 Application**

- 2 A new paragraph 1.2.2 is inserted after the existing paragraph 1.2.1 as follows:

"1.2.2 The recommendations contained herein may also apply to other ships subject to similar external forces, when determining the adequacy of stability."

and the existing paragraphs 1.2.2 and 1.2.3 are renumbered accordingly.

**Chapter 2 – Recommended design criteria for certain types of ships**

- 3 The title of chapter 2 is replaced with the following:

**"Recommended design criteria for ships engaged in certain types of operations and certain types of ships"**

- 4 Paragraph 2.4.3.4 is replaced with the following:

"2.4.3.4 A vessel engaged in towing operations should be provided with means for quick release of the towline.\*"

---

\* Vessels provided with towing winch systems should also be provided with means of quick release."

- 5 The following new sections 2.7 to 2.9 are added after existing section 2.6:

**"2.7 Ships engaged in anchor handling operations**

**2.7.1 Application**

2.7.1.1 The provisions given hereunder apply to ships engaged in anchor handling operations.

2.7.1.2 A *wire* means a dedicated line (wire rope, synthetic rope or chain cable) used for the handling of anchors by means of an anchor handling winch.

## 2.7.2 Heeling levers

2.7.2.1 A heeling lever,  $HL_\varphi$ , generated by the action of a heeling moment caused by the vertical and horizontal components of the tension applied to the wire should be calculated as:

$$HL_\varphi = (M_{AH} / \Delta_2) \cos \varphi$$

where:

$$M_{AH} = F_p \times (h \sin \alpha \times \cos \beta + y \times \sin \beta);$$

$\Delta_2$  = displacement of a loading condition, including action of the vertical loads added ( $F_v$ ), at the centreline in the stern of ship;

$$F_v = F_p \times \sin \beta;$$

$\alpha$  = the horizontal angle between the centreline and the vector at which the wire tension is applied to the ship in the upright position, positive outboard;

$\beta$  = the vertical angle between the waterplane and the vector at which the wire tension is applied to the ship, positive downwards, should be taken at the maximum heeling moment angle as  $\tan^{-1}(y / (h \times \sin \alpha))$ , but not less than  $\cos^{-1}(1.5 B_P / (F_P \cos \alpha))$ , using consistent units;

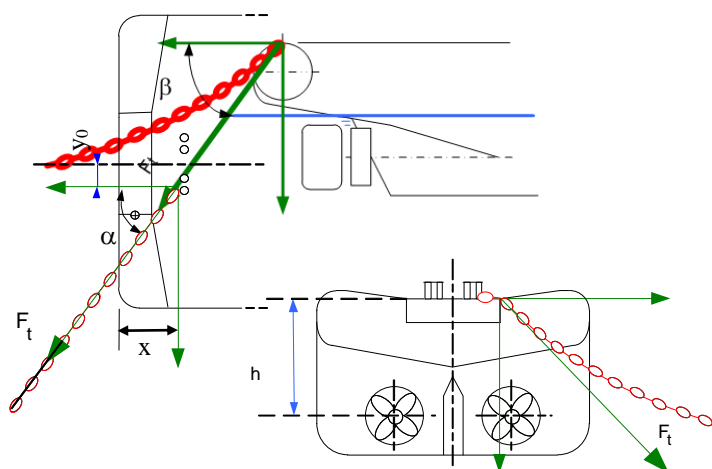

**Figure 2.7-1 – Diagrams showing the intended meaning of parameters  $\alpha$ ,  $\beta$ ,  $x$ ,  $y$  and  $h$ .  $F_t$  shows the vector of the applied wire tension.**

$B_P$  = the Bollard pull that is the documented maximum continuous pull obtained from a static pull test on sea trial, carried out in accordance with annex A of MSC/Circ.884 or an equivalent standard acceptable to the Administration;

$F_p$	=	(Permissible tension) the wire tension which can be applied to the ship as loaded while working through a specified tow pin set, at each $\alpha$ , for which all stability criteria can be met. $F_p$ should in no circumstance be taken as greater than $F_d$ ;
$F_d$	=	(Design maximum wire tension) the maximum winch wire pull or maximum static winch brake holding force, whichever is greater;
$h$	=	the vertical distance (m) from the centre the propulsive force acts on the ship to either: <ul style="list-style-type: none"><li>• the uppermost part at the towing pin, or</li><li>• a point on a line defined between the highest point of the winch pay-out and the top of the stern or any physical restriction of the transverse wire movement;</li></ul>
$y$	=	the transverse distance (m) from the centreline to the outboard point at which the wire tension is applied to the ship given by: $y_0 + x \tan \alpha$ ; but not greater than $B/2$ ;
$B$	=	the moulded breadth (m);
$y_0$	=	the transverse distance (m) between the ship centreline to the inner part of the towing pin or any physical restriction of the transverse wire movement;
$x$	=	the longitudinal distance (m) between the stern and the towing pin or any physical restriction of the transverse wire movement.

### **2.7.3 Permissible tension**

2.7.3.1 The permissible tension as function of  $\alpha$ , defined in paragraph 2.7.2, should not be greater than the tension given by paragraph 2.7.3.2,

2.7.3.2 Permissible tension as function of  $\alpha$  can be calculated by direct stability calculations, provided that the following are met:

- .1 the heeling lever should be taken as defined in paragraph 2.7.2 for each  $\alpha$ ;
- .2 the stability criteria in paragraph 2.7.4, should be met;
- .3  $\alpha$  should not be taken less than 5 degrees, except as permitted by paragraph 2.7.3.3; and
- .4 Intervals of  $\alpha$  should not be more than 5 degrees, except that larger intervals may be accepted, provided that the permissible tension is limited to the higher  $\alpha$  by forming working sectors.

2.7.3.3 For the case of a planned operation to retrieve a stuck anchor in which the ship is on station above the anchor and the ship has low or no speed,  $\alpha$  may be taken as less than 5 degrees.

#### **2.7.4 Stability criteria**

2.7.4.1 For the loading conditions intended for anchor handling, but before commencing the operation, the stability criteria given in paragraph 2.2 of part A, or where a ship's characteristics render compliance with paragraph 2.2 of part A impracticable, the equivalent stability criteria given in paragraph 2.4 of part B, should apply. During operation, under the action of the heeling moment, the criteria under paragraphs 2.7.4.2 to 2.7.4.4 should apply.

2.7.4.2 The residual area between the righting lever curve and the heeling lever curve calculated in accordance with paragraph 2.7.2 should not be less than 0.070 metre-radians. The area is determined from the first intersection of the two curves,  $\varphi_e$ , to the angle of the second intersection,  $\varphi_c$ , or the angle of down-flooding,  $\varphi_f$ , whichever is less.

2.7.4.3 The maximum residual righting lever GZ between the righting lever curve and the heeling lever curve calculated in accordance with paragraph 2.7.2 should be at least 0.2 m.

2.7.4.4 The static angle at the first intersection,  $\varphi_e$ , between the righting lever curve and the heeling lever curve calculated in accordance with paragraph 2.7.2 should not be greater than:

- .1 the angle at which the righting lever equals 50% of the maximum righting lever;
- .2 the deck edge immersion angle; or
- .3 15°,

whichever is less.

2.7.4.5 A minimum freeboard at stern, on centreline, of at least  $0.005L$  should be maintained in all operating conditions, with a displacement given by  $\Delta_2$ , as defined in paragraph 2.7.2. In the case of the anchor retrieval operation covered by paragraph 2.7.3.3, a lower minimum freeboard may be accepted provided that due consideration has been given to this in the operation plan.

#### **2.7.5 Constructional precautions against capsizing**

2.7.5.1 A stability instrument may be used for determining the permissible tension and checking compliance with relevant stability criteria.

Two types of stability instrument may be used on board:

- either a software checking the intended or actual tension on the basis of the permissible tension curves; or

- a software performing direct stability calculations to check compliance with the relevant criteria, for a given loading condition (before application of the tension force), a given tension and a given wire position (defined by angles  $\alpha$  and  $\beta$ ).

2.7.5.2 Access to the machinery space, excluding emergency access and removal hatches, should, if possible, be arranged within the forecastle. Any access to the machinery space from the exposed cargo deck should be provided with two weathertight closures. Access to spaces below the exposed cargo deck should preferably be from a position within or above the superstructure deck.

2.7.5.3 The area of freeing ports in the side bulwarks of the cargo deck should at least meet the requirements of regulation 24 of the International Convention on Load Lines, 1966 or the Protocol of 1988 relating thereto, as amended, as applicable. The disposition of the freeing ports should be carefully considered to ensure the most effective drainage of water trapped in working deck and in recesses at the after end of the forecastle. In ships operating in areas where icing is likely to occur, no shutters should be fitted in the freeing ports.

2.7.5.4 The winch systems should be provided with means of emergency release.

2.7.5.5 For ships engaged in anchor handling operations the following recommendations for the anchor handling arrangements should be considered:

- .1 stop pins or other design features meant to impede the movement of the wire further outboard should be installed; and
- .2 the working deck should be marked with contrasting colours or other identifiers such as guide pins, stop pins or similar easily identifiable points that identify operational zones for the line to aid operator observation.

### **2.7.6 Operational procedures against capsizing**

2.7.6.1 A comprehensive operational plan should be defined for each anchor handling operation, according to the guidelines given in paragraph 3.8, where at least, but not only, the following procedures and emergency measures should be identified:

- .1 environmental conditions for the operation;
- .2 winch operations and movements of weights;
- .3 compliance with the stability criteria, for the different expected loading conditions;
- .4 permissible tensions on the winches as function of  $\alpha$ ; in accordance with paragraph 3.8;
- .5 stop work and corrective procedures; and
- .6 confirmation of the master's duty to take corrective action when necessary.

2.7.6.2 The arrangement of cargo stowed on deck should be such as to avoid any obstruction of the freeing ports or sudden shift of cargo on deck.

2.7.6.3 Counter-ballasting to correct the list of the ship during anchor handling operations should be avoided.

## 2.8 Ships engaged in towing and escort operations

### 2.8.1 Application

The provisions given hereunder apply to ships the keel of which is laid or which is at a similar stage of construction\* on or after 1 January 2020 engaged in harbour towing, coastal or ocean-going towing and escort operations and to ships converted to carry out towing operations after this date.

- \* A similar stage of construction means the stage at which:
- .1 construction identifiable with a specific ship begins; and
  - .2 assembly of that ship has commenced, comprising at least 50 tonnes or 1% of the estimated mass of all structural material, whichever is less.

### 2.8.2 Heeling lever for towing operations

2.8.2.1 The self-tripping heeling lever is calculated as provided below:

- .1 A transverse heeling moment is generated by the maximum transverse thrust exerted by the ship's propulsion and steering systems and the corresponding opposing towline pull.
- .2 The heeling lever  $HL_{\varphi}$ , in (m), as a function of the heeling angle  $\varphi$ , should be calculated according to the following formula:

$$HL_{\varphi} = \frac{BP \times C_T \times (h \times \cos \varphi - r \times \sin \varphi)}{g \times \Delta}$$

where:

$BP$  = bollard pull, in (kN), which is the documented maximum continuous pull obtained from a static bollard pull test performed in accordance with relevant IMO guidelines\* or a standard acceptable to the Administration;

\* Refer to annex A to the *Guidelines for safe ocean towing* (MSC/Circ.884).

- $C_T =$
- 0.5,  
for ships with conventional, non-azimuth propulsion units;
  - $0.90/(1 + //L_{LL})$ ,  
for ships with azimuth propulsion units installed at a single point along the length. However,  $C_T$  should not be less than 0.7 for ships with azimuth stern drive towing over the stern or tractor tugs towing over the bow, and not less than 0.5 for ships with azimuth stern drive towing over the bow or tractor tugs towing over the stern;

For tugs with other propulsion and/or towing arrangements, the value of  $C_T$  is to be established on a case by case basis to the satisfaction of the Administration.

- $\Delta$  = displacement, in (t);
- $l$  = longitudinal distance, in (m), between the towing point and the vertical centreline of the propulsion unit(s) relevant to the towing situation considered;
- $h$  = vertical distance, in (m), between the towing point and the horizontal centreline of the propulsion unit(s) as relevant for the towing situation considered;
- $g$  = gravitational acceleration, in (m/s<sup>2</sup>), to be taken as 9.81;
- $r$  = the transverse distance, in (m), between the centre line and the towing point, to be taken as zero when the towing point is at the centre line.
- $L_{LL}$  = length (L) as defined in the International Convention on Load Lines in force.

The towing point is the location where the towline force is applied to the ship. The towing point may be a towing hook, staple, fairlead or equivalent fitting serving that purpose.

2.8.2.2 The tow-tripping heeling lever  $HL_\varphi$ , in (m), is calculated according to the following formula:

$$HL_\varphi = C_1 \times C_2 \times \gamma \times V^2 \times A_p \times (h \times \cos \varphi - r \times \sin \varphi + C_3 \times d) / (2 \times g \times \Delta)$$

where:

$$C_1 = \text{lateral traction coefficient} = 2.8 \left( \frac{L_s}{L_{pp}} - 0.1 \right) \quad 0.10 \leq C_1 \leq 1.00$$

$$C_2 = \text{correction of } C_1 \text{ for angle of heel} = \left( \frac{\varphi}{3 \cdot \varphi_D} + 0.5 \right) \quad C_2 \geq 1.00$$

$$\text{Angle to deck edge} \quad \varphi_D = \arctan\left(\frac{2f}{B}\right)$$

$C_3$  = distance from the centre of  $A_p$  to the waterline as fraction of the draught related to the heeling angle

$$C_3 = \left( \frac{\varphi}{\varphi_D} \right) \times 0.26 + 0.30 \quad 0.50 \leq C_3 \leq 0.83$$

$\gamma$  = specific gravity of water, in (t/m<sup>3</sup>);

$V$  = lateral velocity, in (m/s), to be taken as 2.57 (5 knots);



$A_P$  = lateral projected area, in (m<sup>2</sup>), of the underwater hull;

$r$  = the transverse distance, in (m), between the centre line and the towing point, to be taken as zero when the towing point is at the centre line;

$L_S$  = the longitudinal distance, in (m), from the aft perpendicular to the towing point;

$L_{PP}$  = length between perpendiculars, in (m);

$\varphi$  = angle of heel;

$f$  = freeboard amidship, in (m);

$B$  = moulded breadth, in (m);

$h$  = vertical distance, in (m), from the waterline to the towing point;

$d$  = actual mean draught, in (m).

The towing point is the location where the towline force is applied to the ship. The towing point may be a towing hook, staple, fairlead or equivalent fitting serving that purpose.

### **2.8.3 Heeling lever for escort operations**

2.8.3.1 For the evaluation of the stability particulars during escort operations the ship is considered to be in an equilibrium position determined by the combined action of the hydrodynamic forces acting on hull and appendages, the thrust force and the towline force as shown in figure 2.8-1.

2.8.3.2 For each equilibrium position the corresponding steering force, braking force, heel angle and heeling lever are to be obtained from the results of full scale trials, model tests, or numerical simulations in accordance with a methodology acceptable to the Administration.

2.8.3.3 For each relevant loading condition the evaluation of the equilibrium positions is to be performed over the applicable escort speed range, whereby the speed of the assisted ship through the water is to be considered.\*

---

\* The typical escort speed range is 6 to 10 knots.

2.8.3.4 For each relevant combination of loading condition and escort speed, the maximum heeling lever is to be used for the evaluation of the stability particulars.

2.8.3.5 For the purpose of stability calculations the heeling lever is to be taken as constant.

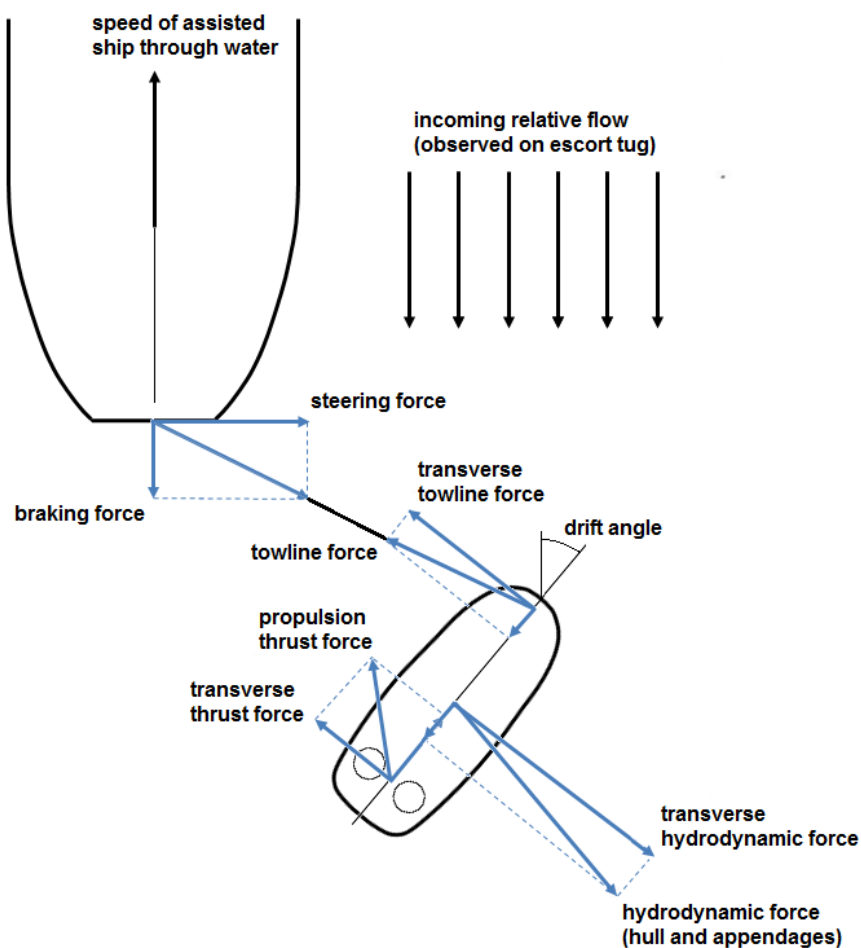

Figure 2.8-1: Escort tug equilibrium position

#### 2.8.4 Stability criteria

2.8.4.1 In addition to the stability criteria given in part A, section 2.2, or the equivalent stability criteria given in chapter 4 of the explanatory notes to the 2008 IS Code where the ship's characteristics render compliance with part A, section 2.2 impracticable, the following stability criteria should be complied with.

2.8.4.2 For ships engaged in harbour, coastal or ocean-going towing operations the area A contained between the righting lever curve and the heeling lever curve calculated in accordance with paragraph 2.8.2.1 (self-tripping), measured from the heel angle,  $\varphi_e$ , to the angle of the second intersection,  $\varphi_c$ , or the angle of down-flooding,  $\varphi_f$ , whichever is less, should be greater than the area B contained between the heeling lever curve and the righting lever curve, measured from the heel angle  $\varphi = 0$  to the heel angle,  $\varphi_e$ .

where:

$\varphi_e$  = Angle of first intersection between the heeling lever and righting lever curves;

- $\varphi_f$  = Angle of down-flooding as defined in part A, paragraph 2.3.1.4 of this Code. Openings required to be fitted with weathertight closing devices under the ICLL but, for operational reasons, are required to be kept open should be considered as down-flooding points in stability calculation;
- $\varphi_c$  = Angle of second intersection between the heeling lever and righting lever curves.

2.8.4.3 For ships engaged in harbour, coastal or ocean-going towing operations the first intersection between the righting lever curve and the heeling lever curve calculated in accordance with paragraph 2.8.2.2 (tow-tripping) should occur at an angle of heel less than the angle of down-flooding,  $\varphi_f$ .

2.8.4.4 For ships engaged in escort operations the maximum heeling lever determined in accordance with paragraph 2.8.3 should comply with the following criteria:

- .1 Area A  $\geq$  1.25  $\times$  Area B;
- .2 Area C  $\geq$  1.40  $\times$  Area D; and
- .3  $\varphi_e \leq$  15 degrees.

where:

- Area A = Righting lever curve area measured from the heel angle  $\varphi_e$  to a heel angle of 20 degrees (see figure 2.8-2);
- Area B = Heeling lever curve area measured from the heeling angle  $\varphi_e$  to a heel angle of 20 degrees (see figure 2.8-2);
- Area C = Righting lever curve area measured from the zero heel ( $\varphi = 0$ ) to  $\varphi_d$  (see figure 2.8-3);
- Area D = Heeling lever curve area measured from zero heel ( $\varphi = 0$ ) to the heeling angle  $\varphi_d$  (see figure 2.8-3);
- $\varphi_e$  = Equilibrium heel angle corresponding to the first intersection between heeling lever curve and the righting lever curve;
- $\varphi_d$  = the heel angle corresponding to the second intersection between heeling lever curve and the righting lever curve or the angle of down-flooding or 40 degrees, whichever is less.

Figure 2.8-2: Areas A and B

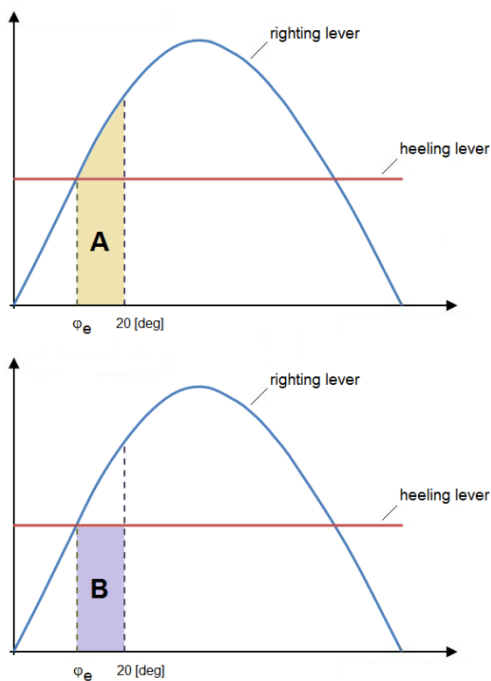
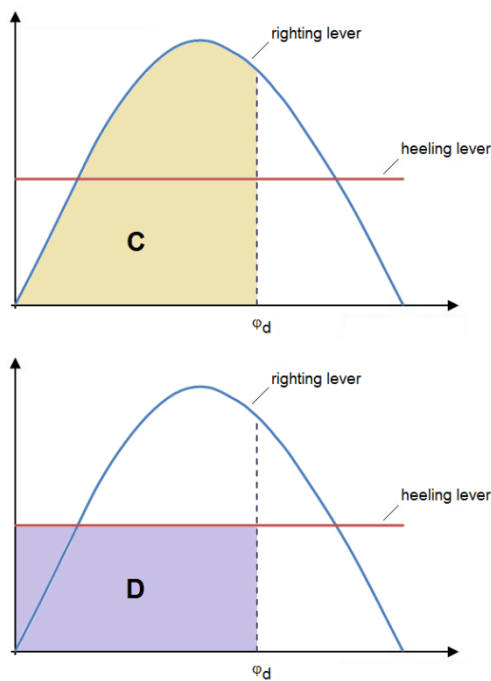

Figure 2.8-3: Areas C and D



### 2.8.5 *Constructional precautions against capsizing*

2.8.5.1 Access to the machinery space, excluding emergency access and removal hatches, should, if possible, be arranged within the forecastle. Any access to the machinery space from the exposed cargo deck should be provided with two weathertight closures, if practicable. Access to spaces below the exposed cargo deck should preferably be from a position within or above the superstructure deck.

2.8.5.2 The area of freeing ports in the side bulwarks of the cargo deck should at least meet the requirements of regulation 24 of the International Convention on Load Lines, 1966 or the Protocol of 1988 relating thereto, as amended, as applicable. The disposition of the freeing ports should be carefully considered to ensure the most effective drainage of water trapped on the working deck and in recesses at the after end of the forecastle. In ships operating in areas where icing is likely to occur, no shutters should be fitted in the freeing ports.

2.8.5.3 A ship engaged in towing operations should be provided with means for quick release of the towline.\*

\* Ships provided with towing winch systems should also be provided with means of quick release.

### 2.8.6 *Operational procedures against capsizing*

2.8.6.1 The arrangement of cargo stowed on deck should be such as to avoid any obstruction of the freeing ports or sudden shift of cargo on deck. Cargo on deck, if any, should not interfere with the movement of the towline.

2.8.6.2 A minimum freeboard at stern of at least  $0.005 \times L_{LL}$  should be maintained in all operating conditions.

## 2.9 Ships engaged in lifting operations

### 2.9.1 Application

2.9.1.1 The provisions given hereunder apply to ships the keel of which is laid or which is at a similar stage of construction\* on or after 1 January 2020 engaged in lifting operations and to ships converted to carry out lifting operations after this date.

- \* A similar stage of construction means the stage at which:
- .1 construction identifiable with a specific ship begins; and
  - .2 assembly of that ship has commenced, comprising at least 50 tonnes or 1% of the estimated mass of all structural material, whichever is less.

2.9.1.2 The provisions of this section should be applied to operations involving the lifting of the ship's own structures or for lifts in which the maximum heeling moment due to the lift is greater than that given in the following:

$$M_L = 0.67 \cdot \Delta \cdot GM \cdot \left( \frac{f}{B} \right)$$

where:

$M_L$  = Threshold value for the heeling moment, in (t.m), induced by the (lifting equipment and) load in the lifting equipment;

$GM$  = The initial metacentric height, in (m), with free surface correction, including the effect of the (lifting equipment and) load in the lifting equipment;

$f$  = the minimum freeboard, in (m), measured from the upper side of the weather deck to the waterline;

$B$  = the moulded breadth of the ship, in (m); and

$\Delta$  = the displacement of the ship, including the lift load, in (t).

The provisions of this section also apply to ships which are engaged in lifting operations where no transverse heeling moment is induced and the increase of the ship's vertical centre of gravity (VCG) due to the lifted weight is greater than 1%.

The calculations should be completed at the most unfavourable loading conditions for which the lifting equipment shall be used.

2.9.1.3 For the purpose of this section, waters that are not exposed are those where the environmental impact on the lifting operation is negligible. Otherwise, waters are to be considered exposed. In general, waters that are not exposed are calm stretches of water, i.e. estuaries, roadsteads, bays, lagoons; where the wind fetch\* is six nautical miles or less.

\* Wind fetch is an unobstructed horizontal distance over which the wind can travel over water in a straight direction.

## **2.9.2 Load and vertical centre of gravity for different types of lifting operations**

2.9.2.1 In lifting operations involving a lifting appliance consisting of a crane, derrick, sheerlegs, a-frame or similar:

- .1 the magnitude of the vertical load ( $P_L$ ) should be the maximum allowed static load at a given outreach of the lifting appliance;
- .2 the transverse distance ( $y$ ) is the transverse distance between the point at which the vertical load is applied to the lifting appliance and the ship centreline in the upright position;
- .3 the vertical height of the load ( $KG_{load}$ ) is taken as the vertical distance from the point at which the vertical load is applied to the lifting appliance to the baseline in the upright position; and
- .4 the change of centre of gravity of the lifting appliance(s) need to be taken into account.

2.9.2.2 In lifting operations not involving a lifting appliance consisting of a crane, derrick, sheerlegs, a-frame or similar, which involve lifting of fully or partially submerged objects over rollers or strong points at or near a deck-level:

- .1 the magnitude of the vertical load ( $P_L$ ) should be the winch brake holding load;
- .2 the transverse distance ( $y$ ) is the transverse distance between the point at which the vertical load is applied to the ship and the ship centreline in the upright position; and
- .3 the vertical height of the load ( $KG_{load}$ ) is taken as the vertical distance from the point at which the vertical load is applied to the ship to the baseline in the upright position.

## **2.9.3 Stability criteria**

2.9.3.1 The stability criteria included herein, or the criteria contained in paragraphs 2.9.4, 2.9.5 or 2.9.7, as applicable shall be satisfied for all loading conditions intended for lifting with the lifting appliance and its load at the most unfavourable positions. For the purpose of this section, the lifting appliance and its load(s) and their centre of gravity (COG) should be included in the displacement and centre of gravity of the ship, in which case no external heeling moment/heeling lever is applied.

2.9.3.2 All loading conditions utilized during the lifting operations are to comply with the stability criteria given in sections 2.2 and 2.3 of part A. Where the ship's characteristics render compliance with section 2.2 of part A impracticable, the equivalent stability criteria given in chapter 4 of the explanatory notes to the 2008 IS Code should apply. During the lifting operation, as determined by paragraphs 2.9.1, the following stability criteria should also apply:

- .1 the equilibrium heel angle,  $\phi_1$ , shall not be greater than the maximum static heeling angle for which the lifting device is designed and which has been considered in the approval of the loading gear;

- .2 during lifting operations in non-exposed waters, the minimum distance between the water level and the highest continuous deck enclosing the watertight hull, taking into account trim and heel at any position along the length of the ship, shall not be less than 0.50 m; and
- .3 during lifting operations in exposed waters, the residual freeboard shall not be less than 1.00 m or 75% of the highest significant wave height  $H_s$ , in (m), encountered during the operation, whichever is greater.

#### **2.9.4 Lifting operations conducted under environmental and operational limitations**

2.9.4.1 For lifting conditions carried out within clearly defined limitations set forth in paragraph 2.9.4.1.1, the intact criteria set forth in paragraph 2.9.4.1.2 may be applied instead of the criteria included in paragraph 2.9.3.

- .1 The limits of the environmental conditions should specify at least the following:
  - the maximum significant wave height,  $H_s$ ; and
  - the maximum wind speed (1 minute sustained at 10 m above sea level).

The limits of the operational conditions should specify at least the following:

- the maximum duration of the lift;
  - limitations in ship speed; and
  - limitations in traffic/traffic control.
- .2 The following stability criteria should apply with the lifted load is at the most unfavourable position:
    - .1 the corner of the highest continuous deck enclosing the watertight hull shall not be submerged;
    - .2  $A_{RL} \geq 1.4 \times A_{HL}$

where:

$A_{RL}$  = The area under the net righting lever curve, corrected for crane heeling moment and for the righting moment provided by the counter ballast if applicable, extending from the equilibrium heeling angle,  $\varphi_1$ , to the angle of down flooding,  $\varphi_F$ , the angle of vanishing stability,  $\varphi_R$ , or the second intersection of the righting lever curve with the wind heeling lever curve, whichever is less, see figure 2.9-1;

$A_{HL}$  = The area below the wind heeling lever curve due to the wind force applied to the ship and the lift at the maximum wind speed specified in paragraph 2.9.4.1.1, see figure 2.9-1.

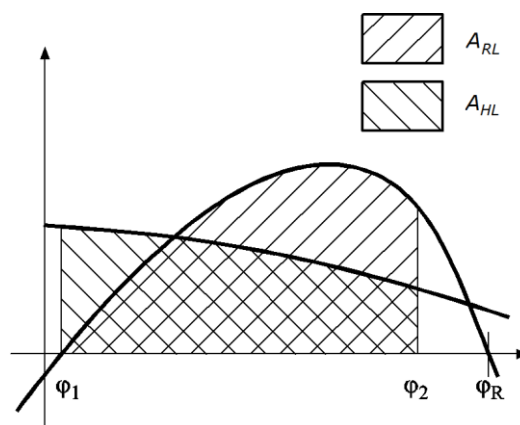

**Figure 2.9-1 – Intact criteria under Environmental and Operational limitations**

- .3 The area under the net righting lever curve from the equilibrium heel angle,  $\phi_1$ , to the down flooding angle  $\phi_F$ , or  $20^\circ$ , whichever is less, shall be at least 0.03 m rad.

### 2.9.5 Sudden loss of hook load

2.9.5.1 A ship engaged in a lifting operation and using counter ballasting should be able to withstand the sudden loss of the hook load, considering the most unfavourable point at which the hook load may be applied to the ship (i.e. largest heeling moment). For this purpose, the area on the side of the ship opposite to the lift (Area 2) should be greater than the residual area on the side of the lift (Area 1), as shown in figure 2.9-2, by an amount given by the following:

Area 2 > 1.4 × Area 1, for lifting operations in waters that are exposed.

Area 2 > 1.0 × Area 1, for lifting operations in waters that are not exposed.

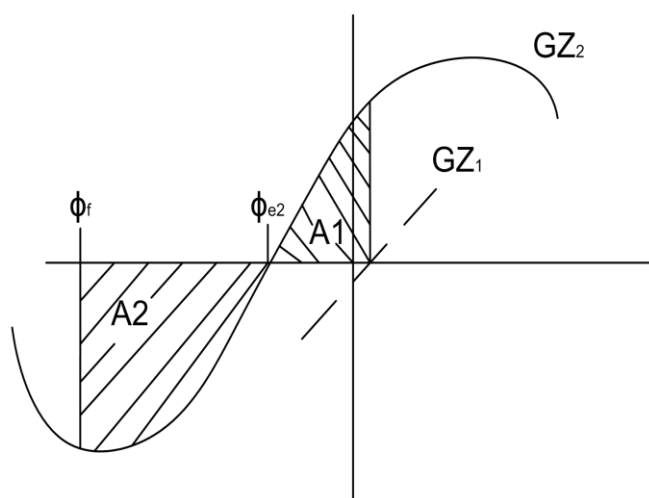

**Figure 2.9-2**



where:

- $GZ_1$  = net righting lever ( $GZ$ ) curve for the condition before loss of crane load, corrected for crane heeling moment and for the righting moment provided by the counter ballast if applicable;
- $GZ_2$  = net righting lever ( $GZ$ ) curve for the condition after loss of crane load, corrected for the transverse moment provided by the counter ballast if applicable;
- $\varphi_{e2}$  = the angle of static equilibrium after loss of crane load;
- $\varphi_f$  = the angle of down-flooding or the heel angle corresponding to the second intersection between heeling and righting arm curves, whichever is less; and

The term "net righting lever" means that the calculation of the  $GZ$  curve includes the ship's true transverse centre of gravity as function of the angle of heel.

### 2.9.6 Alternative method

2.9.6.1 The criteria in paragraph 2.9.6 may be applied to a ship engaged in a lifting operation, as determined by paragraph 2.9.1, as an alternative to the criteria in paragraph 2.9.3 through paragraph 2.9.5, as applicable. For the purpose of this section and the stability criteria set out in paragraph 2.9.7, the lifted load which causes the ship to heel is translated for the purpose of stability calculation to a heeling moment/heeling lever which is applied on the righting lever curve of the ship.

2.9.6.2 The heeling moment applied to the ship due to a lift and the associated heeling lever should be calculated using the following formulae:

$$HM_{\varphi} = P_L \cdot y \cdot \cos \varphi$$

$$HL_{\varphi} = HM_{\varphi} \div \Delta$$

where:

- $HM_{\varphi}$  = the heeling moment, in (t·m), due to the lift at  $\varphi$ ;
- $P_L$  = the vertical load, in (t), of the lift, as defined in 2.9.2.1.1;
- $y$  = the transverse distance, in (m), of the lift, metres, as defined in 2.9.2.1.2;
- $\varphi$  = the angle of heel;
- $HL_{\varphi}$  = the heeling lever, in (m) due to the lift at  $\varphi$ ; and
- $\Delta$  = the displacement, in (t) of the ship with the load of the lift.

2.9.6.3 For application of the criteria contained in paragraph 2.9.7 involving the sudden loss of load of the lift in which counter-ballast is used, the heeling levers that include the counter-ballast should be calculated using the following formulae:

$$CHL_1 = \frac{(P_L \cdot y - CBM) \cdot \cos \varphi}{\Delta}$$

$$CBHL_2 = \frac{CBM \cdot \cos \varphi}{(\Delta - P_L)}$$

where:

- $CBM$  = the heeling moment, in (tm), due to the counter-ballast;
- $CHL_1$  = combined heeling lever, in (m), due to the load of the lift and the counter-ballast heeling moment at the displacement corresponding to the ship with the load of the lift; and
- $CBHL_2$  = heeling lever, in (m), due to the counter-ballast heeling moment at the displacement corresponding to the ship without the load of the lift.

2.9.6.4 The equilibrium heel angle  $\varphi_e$  referred to in 2.9.7 means the angle of first intersection between the righting lever curve and the heeling lever curve.

### **2.9.7 Alternative stability criteria**

2.9.7.1 For the loading conditions intended for lifting, but before commencing the operation, the stability criteria given in sections 2.2 and 2.3 of part A should be complied with. Where a ship's characteristics render compliance with section 2.2 of part A impracticable, the equivalent stability criteria given in chapter 4 of the explanatory notes to the 2008 IS Code should apply. During the lifting operation, as determined by paragraph 2.9.1, the following stability criteria should apply:

- .1 the residual righting area below the righting lever and above the heeling lever curve between  $\varphi_e$  and the lesser of 40° or the angle of the maximum residual righting lever should not be less than:  
  
0.080 m rad, if lifting operations are performed in waters that are exposed; or  
  
0.053 m rad, if lifting operations are performed in waters that are not exposed;
- .2 in addition, the equilibrium angle is to be limited to the lesser of the following:
  - .1 10 degrees;
  - .2 the angle of immersion of the highest continuous deck enclosing the watertight hull; or
  - .3 the lifting appliance allowable value of trim/heel (data to be derived from sidelead and offlead allowable values obtained from manufacturer).

2.9.7.2 A ship engaged in a lifting operation and using counter ballasting should be able to withstand the sudden loss of the hook load, considering the most unfavourable point at which the hook load may be applied to the ship (i.e. largest heeling moment). For this purpose, the area on the side of the ship opposite from the lift (Area 2) in figure 2.9-3 should be greater than the residual area on the side of the lift (Area 1) in figure 2.9-3 by an amount given by the following:

$$\text{Area 2} - \text{Area 1} > K,$$

where:

- $K = 0.037$  m rad, for a lifting operation in waters that are exposed; and  
 $K = 0.0$  m rad, for a lifting operation in waters that are not exposed.

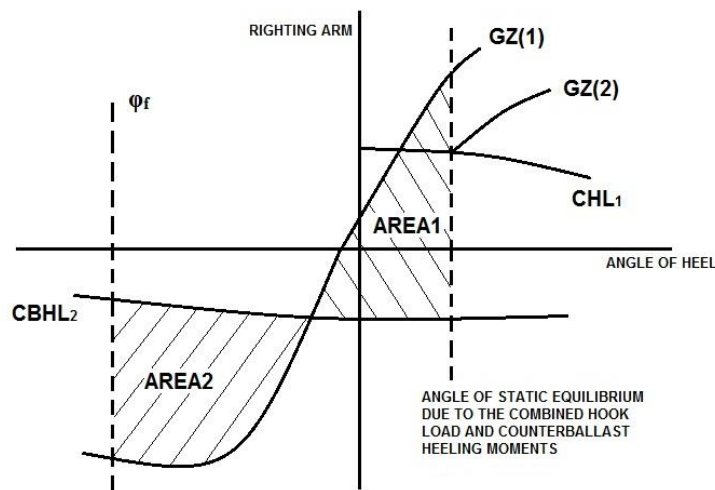

**Figure 2.9-3**

- $GZ(1)$  = The righting arm curve at the displacement corresponding to the ship without hook load;  
 $GZ(2)$  = The righting arm curve at the displacement corresponding to the ship with hook load;  
 $Area2$  = residual area between  $GZ(1)$  and  $CBHL_2$  up to the lesser of the down-flooding angle or the second intersection of  $GZ(2)$  and  $CBHL_2$ ;  
 $Area1$  = residual area below  $GZ(1)$  and above  $CBHL_2$  up to  $\phi_e$ .

### **2.9.8 Model tests or direct calculations**

2.9.8.1 Model tests or direct calculations, performed in accordance with a methodology acceptable to the Administration, that demonstrate the survivability of the ship after sudden loss of hook load, may be allowed as an alternative to complying with the requirements of paragraph 2.9.5 or 2.9.7.2, provided that:

- .1 the effects of wind and waves are taken into account; and
- .2 the maximum dynamic roll amplitude of the ship after loss of load will not cause immersion of unprotected openings.

### **2.9.9 Operational procedures against capsizing**

2.9.9.1 Ships should avoid resonant roll conditions when engaged in lifting operations."

### Chapter 3 – Guidance in preparing stability information

#### 3.4 Standard conditions of loading to be examined

##### 3.4.1 Loading conditions

6 The following new paragraphs 3.4.1.7 to 3.4.1.10 are added after existing paragraph 3.4.1.6:

"3.4.1.7 For a ship engaged in an anchor handling operation, the standard loading conditions should be as follows, in addition to the standard loading conditions for a cargo ship in paragraph 3.4.1.2:

- .1 service loading condition at the maximum draught at which anchor handling operations may occur with the heeling levers as defined in paragraph 2.7.2 for the line tension the ship is capable of with a minimum of 67% stores and fuel, in which all the relevant stability criteria as defined in paragraph 2.7.4 are met;
- .2 service loading condition at the minimum draught at which anchor handling operations may occur with the heeling levers as defined in paragraph 2.7.2 for the line tension the ship is capable of with 10% stores and fuel, in which all the relevant stability criteria as defined in paragraph 2.7.4 are met.

3.4.1.8 For a ship engaged in a harbour, coastal or ocean going towing operation and/or escort operation, the following loading conditions should be included in addition to the standard loading conditions for a cargo ship in paragraph 3.4.1.2:

- .1 maximum operational draught at which towing or escorting operations are carried out, considering full stores and fuel;
- .2 minimum operational draught at which towing or escorting operations are carried out, considering 10% stores and fuel; and
- .3 intermediate condition with 50% stores and fuel.

3.4.1.9 For ships engaged in lifting, loading conditions reflecting the operational limitations of the ship, while engaged in lifting shall be included in the stability booklet. Use of counter ballast, if applicable, shall be clearly documented, and the adequacy of the ships stability in the event of the sudden loss of the hook load shall be demonstrated.

3.4.1.10 The criteria stated in paragraphs 2.9.3, 2.9.4, 2.9.5 or 2.9.7, as applicable, shall be satisfied for all loading conditions intended for lifting and with the hook load at the most unfavourable positions. For each loading condition, the weight and centre of gravity of the load being lifted, the lifting appliance, and counter ballast, if any, should be included. The most unfavourable position may be obtained from the load chart and is chosen at the position where the total of the transverse and vertical moment is the greatest. Additional loading conditions corresponding to various boom positions and counter ballast with different filling level (if applicable) may need to be checked."

### **3.4.2 Assumptions for calculating loading conditions**

7 In paragraph 3.4.2.3, the following sentence is inserted at the end:

"If a ship operates in zones where ice accretion is likely to occur, allowance for icing should be made in accordance with the provisions of chapter 6 (Icing considerations)."

8 Subparagraph 3.4.2.7.5 is deleted.

9 Subparagraph 3.4.2.8.2 is deleted and the remaining subparagraphs are renumbered accordingly.

10 The following new paragraphs 3.4.2.9 to 3.4.2.11 are added as follows:

"3.4.2.9 For ships engaged in harbour, coastal or ocean going towing, escort towing, anchor handling or lifting operations, allowance should be made for the anticipated weight of cargo on and below deck, chain in lockers, anticipated type of wire or rope on storage reels and wire on the winches when calculating loading conditions.

3.4.2.10 For ships engaged in anchor handling operations, the compliance with the relevant stability criteria should be made for each set of towing pins and its associated permissible line tensions, including any physical element or arrangement that can restrict the line movement.

3.4.2.11 For ships engaged in anchor handling operations, the reference loading conditions in paragraph 3.4.1.8 should meet the stability criteria in paragraph 2.7.4 when applying the design tension  $F_d$ , for the tow pin set nearest to centreline, as a minimum for the lowest  $\alpha$  equal to 5 degrees."

### **3.5 Calculation of stability curves**

11 The following new section 3.5.4 is added after existing section 3.5.3:

#### **"3.5.4 Calculation of stability curves for ships engaged in anchor handling operations to which section 2.7 applies**

3.5.4.1 Curves (or tables) of the permissible tension as a function of permissible KG (or GM) are to be provided for the draught (or displacement) and trim values covering the intended anchor handling operations. The curves (or tables) should be developed under the following assumptions:

- .1 the maximum allowable KG from the approved stability booklet;
- .2 information of permissible tension curve or table for each set of towing pins, including any physical element or arrangement that can restrict the line movement as function of the stability limiting curve should be included;
- .3 where desirable, a permissible tension curve or table should be provided for any specific loading condition;
- .4 the draught (or displacement), trim and KG (or GM) to be taken into consideration are those before application of the tension; and

- .5 where tables are provided that divide the operational, cautionary, and stop work zones, referred to in paragraph 3.8.2 ("Green", "Yellow" or "Amber", "Red" colour codes, respectively) the limiting angles associated with physical features of the stern, including the roller, may be used to define the boundaries between the operational and cautionary zones (green/yellow boundary) and the cautionary and stop work zones (yellow/red boundary)."

### **3.6 Stability booklet**

12 The following new paragraphs 3.6.3 to 3.6.5 are inserted after existing paragraph 3.6.2:

"3.6.3 The stability manual for ships engaged in anchor handling operations should contain additional information on:

- .1 maximum bollard pull, winch pull capacity and brake holding force;
- .2 details on the anchor handling arrangement such as location of the fastening point of the wire, type and arrangement of towing pins, stern roller, all points or elements where the tension is applied to the ship;
- .3 identification of critical downflooding openings;
- .4 guidance on the permissible tensions for each mode of operation and for each set of towing pins, including any physical element or arrangement that can restrict the wire movement, as function of all relevant stability criteria; and
- .5 recommendations on the use of roll reduction systems.

3.6.4 The stability booklet for ships engaged in harbour, coastal or ocean going towing operations and/or escort operations should contain additional information on:

- .1 maximum bollard pull;
- .2 details on the towing arrangement, including location and type of the towing point(s), such as towing hook, staple, fairlead or any other point serving that purpose;
- .3 identification of critical down-flooding openings;
- .4 recommendations on the use of roll reduction systems;
- .5 if any wire, etc. is included as part of the lightship weight, clear guidance on the quantity and size should be given;
- .6 maximum and minimum draught for towing and escort operations;
- .7 instructions on the use of the quick-release device; and

- .8 for ships engaged in escort operations, the following additional operating information should be included:
  - .1 a table with permissible limits of the heel angle in accordance with the criteria included in paragraph 2.7.3.4 as function of loading condition and escort speed; and
  - .2 instructions on the available means to limit the heel angle within the permissible limits.

3.6.5 For ships engaged in lifting operations, for which section 2.9 applies, additional documentation should be included in the stability booklet:

- .1 maximum heeling moment for each direction of lift/inclination as a function of the counter-ballast heeling moment, if used, the draught, and vertical centre of gravity;
- .2 where fixed counter ballast is used, the following information should be included:
  - .1 weight of the fixed counter ballast; and
  - .2 centre of gravity (LCG, TCG, VCG) of the fixed counter ballast;
- .3 loading conditions over the range of draughts for which lifting operations may be conducted with the maximum vertical load of the lift. Where applicable, righting lever curves for both before and after load drop should be presented for each loading condition;
- .4 limitations on crane operation, including permissible heeling angles, if provided;
- .5 operational limitations, such as:
  - .1 Maximum Safe Working Load (SWL);
  - .2 maximum radius of operation of all derricks and lifting appliances;
  - .3 maximum load moment; and
  - .4 environmental condition affecting the stability of the ship;
- .6 instructions related to normal crane operation, including those for use of counter ballast;
- .7 instructions such as ballasting/de-ballasting procedures to righting the ship following an accidental load drop;
- .8 identification of critical down-flooding openings;
- .9 recommendations on the use of roll reduction systems;

- .10 drawing of the crane showing the weight and centre of gravity, including heel/trim limitations established by the crane manufacturer;
- .11 a crane load chart, with appropriate de-ratings for wave height;
- .12 load chart for lifting operations covering the range of operational draughts related to lifting and including a summary of the stability results;
- .13 a crane specification manual provided by the manufacturer shall be submitted separately for information;
- .14 the lifting appliance load, radius, boom angle limit table, including identification of offlead and sidelead angle limits and slewing angle range limits and reference to the ship's centreline;
- .15 a table that relates the ship trim and heel to the load, radius, slewing angle and limits, and the offlead and sidelead limits;
- .16 procedures for calculating the offlead and sidelead angles and the ship VCG with the load applied;
- .17 if installed, data associated with a Load Moment Indicator system and metrics included in the system;
- .18 if lifting appliance (crane) offlead and sidelead determine the maximum ship equilibrium angle, the stability booklet should include a note identifying the lifting appliance as the stability limiting factor during lifting operations; and
- .19 information regarding the deployment of (stability) pontoons to assist a lifting operation, if fitted.

The information in subparagraphs .2 to .19 above may be included in other ship specific documentation on board the ship. In that case, a reference to these documents shall be included in the stability booklet."

and the existing paragraphs 3.6.3, 3.6.4 and 3.6.5 are renumbered as paragraphs 3.6.6, 3.6.7 and 3.6.8 accordingly.

### **3.8 Operating booklets for certain ships**

13 The following new sections 3.8 and 3.9 are inserted after existing section 3.7:

#### **"3.8 Operational and planning manuals for ships engaged in anchor handling for which section 2.7 applies:**

3.8.1 To assist the master an operational and planning manual containing guidelines for planning and performing specific operations should be provided on board. The guidelines should contain sufficient information to enable the master to plan and operate the ship in compliance with the applicable requirements contained in this Code. The following information should be included as appropriate:



- .1 anchor handling arrangements, including:
  - detail arrangement of anchor handling deck equipment (winches, wire stoppers, towing pins, etc.);
  - typical arrangement of cargo on deck (anchors, wires, chain cables, etc.);
  - chain lockers used for mooring deployment;
  - anchor handling/towing winch;
  - tugger winches;
  - stern roller, including lateral limits on both ends;
  - lifting appliances, if any and if forming a physical restriction as per paragraph 3.4.2.10; and
  - typical paths of wires between winches and stern roller, showing the limit sectors; and
- .2 detailed data of the permissible tensions, stability limiting curves, and recommendations for calculating ship's loading conditions including sample calculations.

3.8.2 An operation plan should be agreed to by the master of the ship and a copy archived on a remote location before the operation commences. Guidelines and procedures to define a step-wise operational plan for a specific operation should contain instructions for:

- .1 identifying and calculating loading conditions for all relevant stages of operation, taken into account the expected fuel and stores consumption, alterations on deck load, effects of deployment or recovering of the wire on the winches and chain lockers;
- .2 planning ballast operations;
- .3 defining the most favourable consumption sequence and identifying the most onerous situations;
- .4 identifying the possibility or prohibition of using the roll reduction systems in all operational stages;
- .5 operation with open chain lockers, e.g. additional loading conditions for asymmetric filling or other measures to reduce the possibility of flooding;
- .6 collect updated weather forecasts, and to define environmental conditions for anchor handling operations;
- .7 the use of limiting stability curves and intended tensions;

- .8 defining the stop work limits:
  - .a permissible tensions and operational sectors for  $\alpha$ ;
  - .b heeling angles in compliance with the stability criteria; and
  - .c environmental conditions;
- .9 implement and define corrective and emergency procedures;
- .10 define:
  - .a an operational zone in which normal operations up to the permissible tension are to occur (i.e. a "Green" zone);
  - .b a cautionary zone (i.e. a "Yellow" or "Amber" zone) where operations may be reduced or halted to assess the ship's options to return to the operational or Green Zone: the cautionary zone should be not less than an angle of 10 degrees unless table 3.8.3 provides otherwise; and
  - .c a "Stop work" zone (i.e. a "Red" zone) in which the operation should be stopped, for which, in normal operations, the yellow/red boundary should not exceed 45 degrees or the point at which the wire rises above the deck. Notwithstanding this, due consideration may be given to different operations from typical anchor handling operations where the planned operation ensures the safety of the ship; and
- .11 examples of presentation of permissible tensions are presented in annex 3 to part B.

3.8.3 To aid the definition of permissible tensions and zones based on the availability of tension monitoring and an onboard stability instrument the following table is provided.

**Table 3.8.3**

Availability of Tension Monitoring and an onboard Stability Instrument	Tension monitoring is not available	Tension monitoring is available but no stability instrument is available	Both tension monitoring and a stability instrument is available
Permissible tension, $F_p$	Design Maximum Line Tension, $F_p$ , in the operational zone.	$F_p$ as described in Stability Booklet, the operational planning guidelines, or the specific operational plan.	$F_p$ as calculated by the Stability Instrument for the actual loading condition.
Permissible table	First $\alpha$ should be 5°. The only permissible tension is the Design maximum wire	Tables may be prepared for different values of draft, trim, KG or	Tables or curves provided in the stability booklet may be used where $F_p$

Availability of Tension Monitoring and an onboard Stability Instrument	Tension monitoring is not available	Tension monitoring is available but no stability instrument is available	Both tension monitoring and a stability instrument is available
	<p>Tension, <math>F_d</math>. Figures in the table will be <math>F_d</math> for <math>\alpha</math> for which <math>F_p \geq F_d</math>. The cautionary zone would include positions where <math>F_d &gt; F_p \geq</math> maximum winch wire pull. The stop work zone is every other position where <math>F_p &lt;</math> the maximum winch wire pull. If criteria is not fulfilled at <math>\alpha = 5^\circ</math> anchor handling should not be performed without winch modification.</p>	<p>GM, or specific predefined loading conditions. Values in the table should range from <math>\alpha = 0</math> to <math>\alpha = 90^\circ</math>. A table should identify <math>F_p</math> at critical points and the table should be provided for each set of towing pins.</p>	<p>throughout the nonspecific operational zone exceeds the maximum anticipated wire tension; otherwise, tables or curves calculated for the actual loading condition must be developed.</p>

Availability of Tension Monitoring and an onboard Stability Instrument	Tension monitoring is not available	Tension monitoring is available but no stability instrument is available	Both tension monitoring and a stability instrument is available
Zones	<p>The operational zone should be defined as the sector between the two outboard <math>\alpha</math> values for which <math>F_p \geq F_d</math>. The cautionary zone should be defined as the sector between the <math>\alpha</math> at which <math>F_p = F_d</math> and <math>\alpha</math> at which <math>F_p =</math> maximum winch wire pull. The stop work zone should cover every other position. The sectors should be documented in the Stability Booklet, the operational planning guidelines, or the specific operational plan. The sector diagram may be prepared for multiple loading conditions. If the limiting <math>\alpha</math> is less than <math>5^\circ</math> anchor handling operations should not be performed without winch modifications.</p>	<p>The zones may be developed based on normal operational practices contained in the operational planning guidelines, e.g. the operational zone on the stern roller, cautionary zone for not more than <math>15\text{deg}</math> past the stern roller and the red zone otherwise or developed for a specific operation where the outboard <math>\alpha</math> values at which <math>F_p =</math> maximum anticipated wire tension minus <math>10^\circ</math> defines the operational zone, if <math>\alpha</math> is greater than <math>20^\circ</math>. If this <math>\alpha</math> is less than <math>20^\circ</math>, the operational zone is defined as the sector between <math>\frac{1}{2}</math> the outboard <math>\alpha</math> values at which <math>F_p =</math> maximum anticipated wire tension. In each case, the cautionary zone is defined between the limit of the operational zone and the <math>\alpha</math> value at which <math>F_p =</math> maximum anticipated wire tension. In each case, the operational zone must be identified for the anticipated wire tension.</p>	<p>The zones may be developed based on normal operational practices contained in the operational planning guidelines, e.g. the operational zone on the stern roller, cautionary zone for not more than <math>15\text{deg}</math> past the stern roller and the red zone otherwise or developed for a specific operation where the outboard <math>\alpha</math> values at which <math>F_p =</math> maximum anticipated wire tension minus <math>10^\circ</math> defines the operational zone, if <math>\alpha</math> is greater than <math>20^\circ</math>. If this <math>\alpha</math> is less than <math>20^\circ</math>, the operational zone is defined as the sector between <math>\frac{1}{2}</math> the outboard <math>\alpha</math> values at which <math>F_p =</math> maximum anticipated wire tension. In each case, the cautionary zone is defined between the limit of the operational zone and the <math>\alpha</math> value at which <math>F_p =</math> maximum anticipated wire tension. In each case, the operational zone must be identified for the anticipated wire tension.</p>

**3.9 Operational and planning booklets for ships engaged in lifting for which section 2.9 applies**

3.9.1 An operation plan should be agreed to by the Master of the ship and a copy archived on a remote location before the operation commences. To assist the master an operational and planning booklet containing guidelines for planning and performing specific operations should be provided on board.

3.9.2 The guidelines should contain sufficient information to enable the Master to plan and operate the ship in compliance with the applicable requirements contained in this Code. The following information should be included as appropriate:

- .1 lifting arrangements, capabilities and procedures to operate the lifting systems; and
- .2 detailed data concerning the ship's lifting capability, operational limitations, limitations of cargo capacities, stability limiting curves and recommendations for calculating ship's loading conditions including sample calculations.

3.9.3 Guidelines and procedures to define a step-wise operational plan for a specific operation should contain instructions for:

- .1 identifying and calculating loading conditions for all relevant stages of operation, taking into account the alterations on deck load, effects of deployment or recovering of the line on the winches (in particular for deep water lifting);
- .2 planning ballast or counter ballast operations;
- .3 identifying the possibility to use the roll reduction systems in all operational stages;
- .4 collecting latest weather forecasts in order to define the environmental conditions for the intended lifting operation;
- .5 using limiting stability curves, if applicable;
- .6 defining the stop work limits:
  - .1 heeling angles in compliance with the stability criteria; and
  - .2 environmental conditions; and
- .7 defining and implementing corrective and emergency procedures."

and the existing section 3.8 is renumbered as section 3.10.

## **Chapter 4 – Stability calculations performed by stability instruments**

### **4.1 *Stability instruments***

#### 4.1.4 Functional requirements

14 The following new paragraph 4.1.4.2 is inserted after existing paragraph 4.1.4.1:

"4.1.4.2 For ships engaged in anchor handling operations planning tools should be provided in compliance with operational manual requirements. Information such as ballasting and consumables sequences, permissible tension, working sectors, heeling angles and use of roll-reduction devices should be stated."

and the existing paragraphs 4.1.4.2 to 4.1.4.7 are renumbered as 4.1.4.3 to 4.1.4.8 accordingly.

Part B – Annexes

15 A new annex 3 is added at the end of part B as follows:

"Annex 3

Recommended model for graphic or tabular presentation of permissible tensions for use in anchor handling operations.

The insertion of a recommended model for the presentation of permissible tensions as function of  $\alpha$  might be beneficial for a universal information standard. This uniform presentation will facilitate the circulation and the familiarization of the operators with the ship and its equipment.

A possible graphic presentation of the permissible tension is here included as an example, both table and diagram format.

PERMISSIBLE WIRE TENSION TABLE FOR A SAMPLE AHTS																					
Trim (M)	-0.5	0.0	0.5	-0.5	0.0	0.5	-0.5	0.0	0.5	-0.5	0.0	0.5									
Angle $\alpha$	0			10			20			30			45			60			90		
Draft (M)																					
<b>Between the Centerline Towing Pins</b>																					
4.8	700	700	700	700	700	690	623	580	540	460	460	433	290	290	290	190	190	190	163	163	163
5.8	700	700	700	700	700	690	633	600	550	430	483	433	283	283	310	190	180	200	170	163	170
6.8	700	633	520	700	633	520	643	573	510	350	483	413	353	353	305	230	240	220	200	205	200
<b>Between the Outer Towing Pins</b>																					
4.8	343	300	463	480	433	403	383	380	350	300	300	300	213	213	213	170	170	170	163	163	163
5.8	373	320	463	300	433	403	360	390	350	273	300	300	220	210	240	180	173	190	170	163	170
6.8	353	480	410	300	433	370	440	383	330	363	340	293	260	270	233	210	213	200	200	203	200
<b>Towing Pin at the Edge of the Cargo Rail</b>																					
4.8	280	280	270	260	260	260	233	233	233	213	213	213	180	180	180	170	170	170	160	160	160
5.8	253	290	280	240	260	263	230	233	250	210	200	233	190	180	200	173	170	180	163	160	163
6.8	343	310	270	320	300	260	290	283	243	260	270	230	220	230	210	203	210	200	193	200	193
Max Wire Pull: 600 t    Max Brake Force: 700 t    Max Dynamic Brake: 700 t    Resulting Fd = 700 t																					
Trim is Negative by the bow. Interpolate between drafts only. For trim between table values, use lower permissible tension.						Permissible tensions shown are in Tonnes. Required tension should not exceed the winches capabilities or the values in the above table.															
Table is for Planning and Monitoring AHTS operation. Specific loading conditions may be required for each anchor move.						If wire angle falls into the yellow zone, and wire tension exceeds the permissible value, corrective actions are required															
Trim should be minimized or by bow for anchor moves where high wire tensions are expected.						If wire angle falls into the red zone, and the wire tension exceeds the permissible value, halt operations, reduce line tension															
Wire angle (alpha $\alpha$ ) is relative to vessel's centerline, and is assumed to always be outboard. If angle is exceeded, use next higher angle.						If planned wire tension exceeds green values above, additional Calculations required. Operations should not be planned for high angles.															
Grey region indicates where the angle of tow wire is not geometrically possible. Permissible tensions are provided for reference only.						Vessel loading must be in accordance with the approved stability book and include any assumed margins															

Figure A3-1: Permissible tension table for ship with 3 tow points

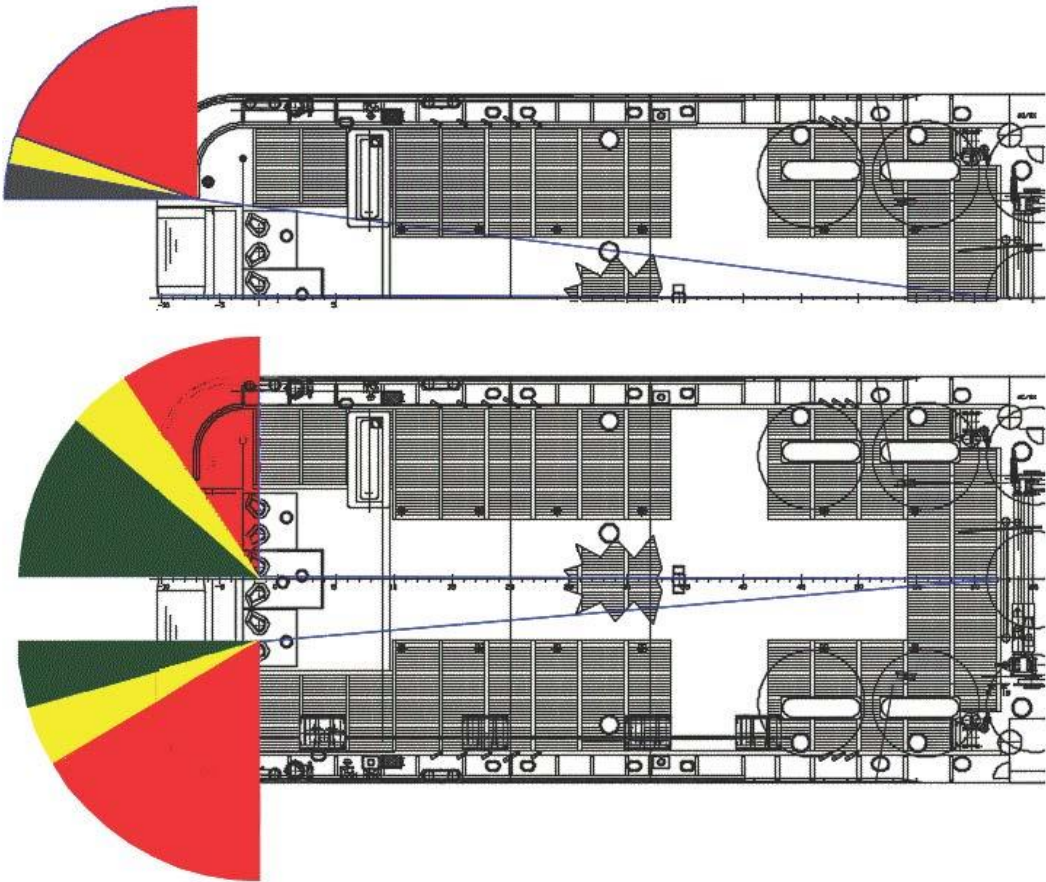

**Figure A3-2: Illustration of the operational, cautionary, and stop work zones (coded respectively "Green", "Yellow" and "Red" zones)**



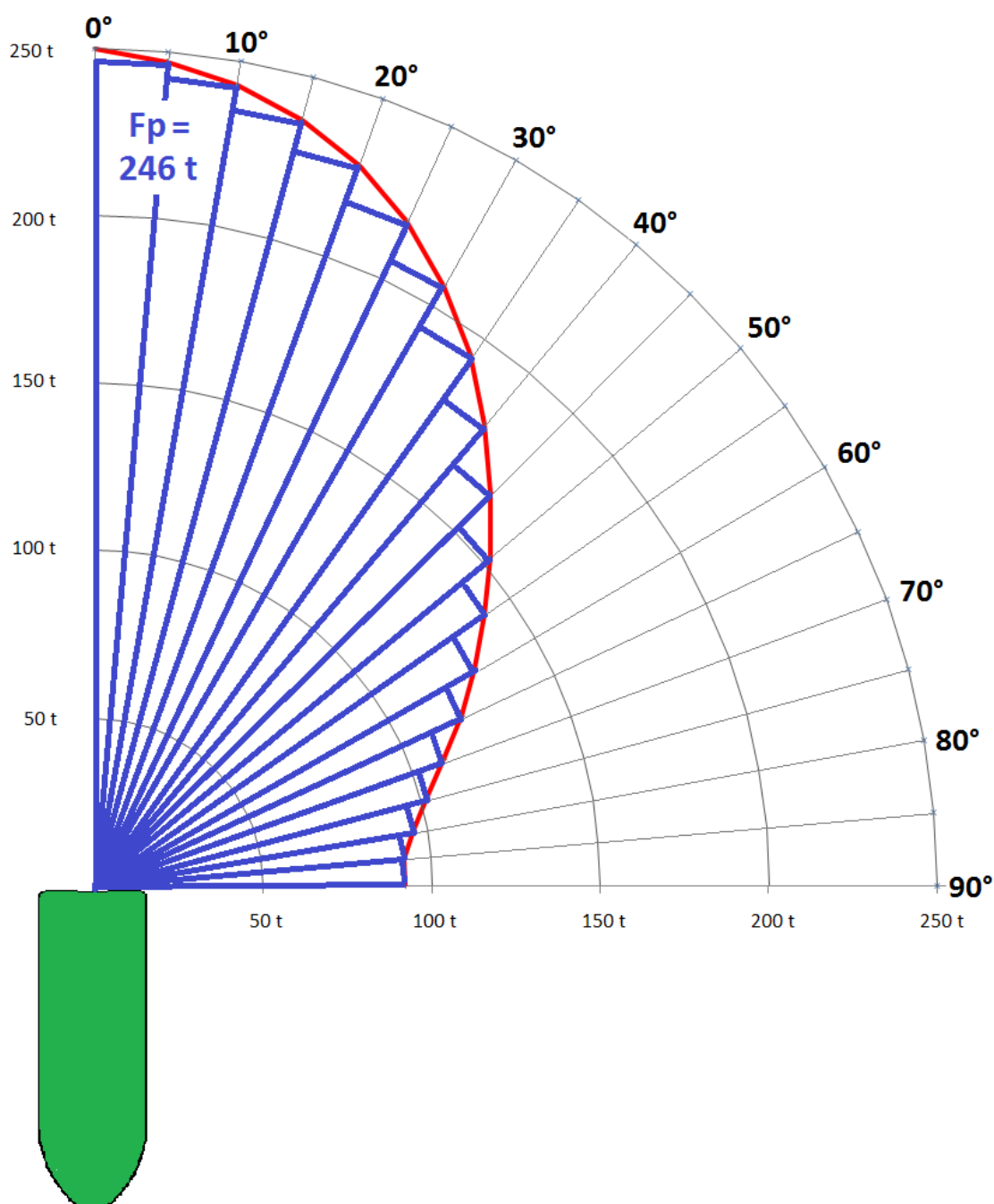

Figure A3-3: Permissible tension sector diagram based on standard alpha values (5°, 10°, 15°, 90°) "

\*\*\*